

Rubber Blocks

Castel Engineering Polska Sp. z o.o. • Tomaszowice Kol.126 • 21-002 Tomaszowice

RB40



Product data:

Product code: RB40

Dimension(LxWXH): 400x130x95

Specification:

The support is made of sorted recycling rubber SBR with embedded aluminum profile.

Application:

As support under the air conditioning units, ventilation ducts, pipelines and other installations.

Materials:

- sized granulated rubber (SBR rubber recycling),
- neutral polyurethane glue ,
- aluminum

Technical data and dimensions

Dimension	Measure [mm]	Tolerance [mm]
L	400	-0 +5
W	130	± 2
H	95	± 2
A	90	± 2
B	80,5	± 2
C	80	± 2
D	30	± 2
E	45	± 2

Weight: 3,08kg ± 10%

Load: 180 kg / 1 pcs

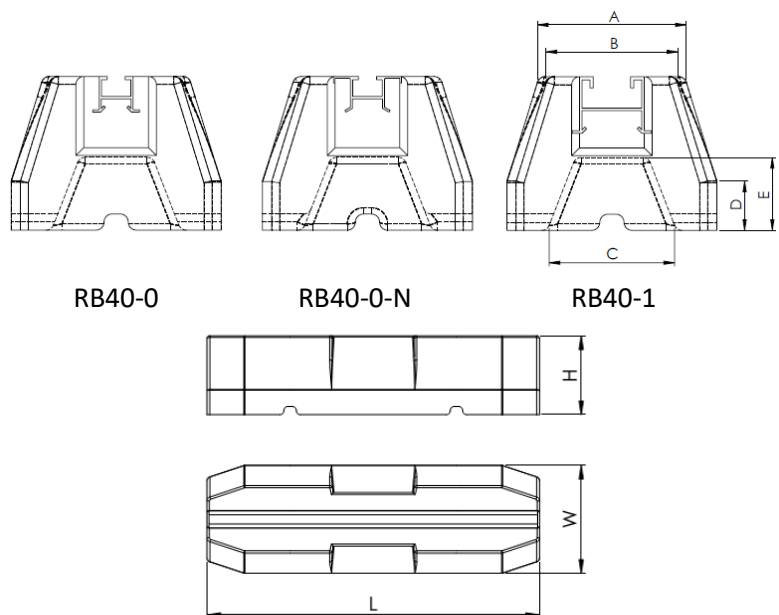

All products Fame Foot must in fact be installed according to the manufacturer's roof systems. The manufacturer of PVC membranes should advise on tendency to migration of plasticizers and define specific recommendations that should be taken into account during installation and which will guarantee that the roof is not affected.

Castel Engineering, Rue de la Royenne 84, B-7700 Mouscron ,branch Castel Engineering Polska Sp. z o.o. Tel. +48 81 503 28 22, Fax +48 81 503 15 55
Copyright © 2016 Castel Engineering – All rights reserved.

The manufacturer reserve rights to make any changes to the product at any time without having to communicate.